

SECTION III

DIAGRAMS

PLANS ET ILLUSTRATIONS

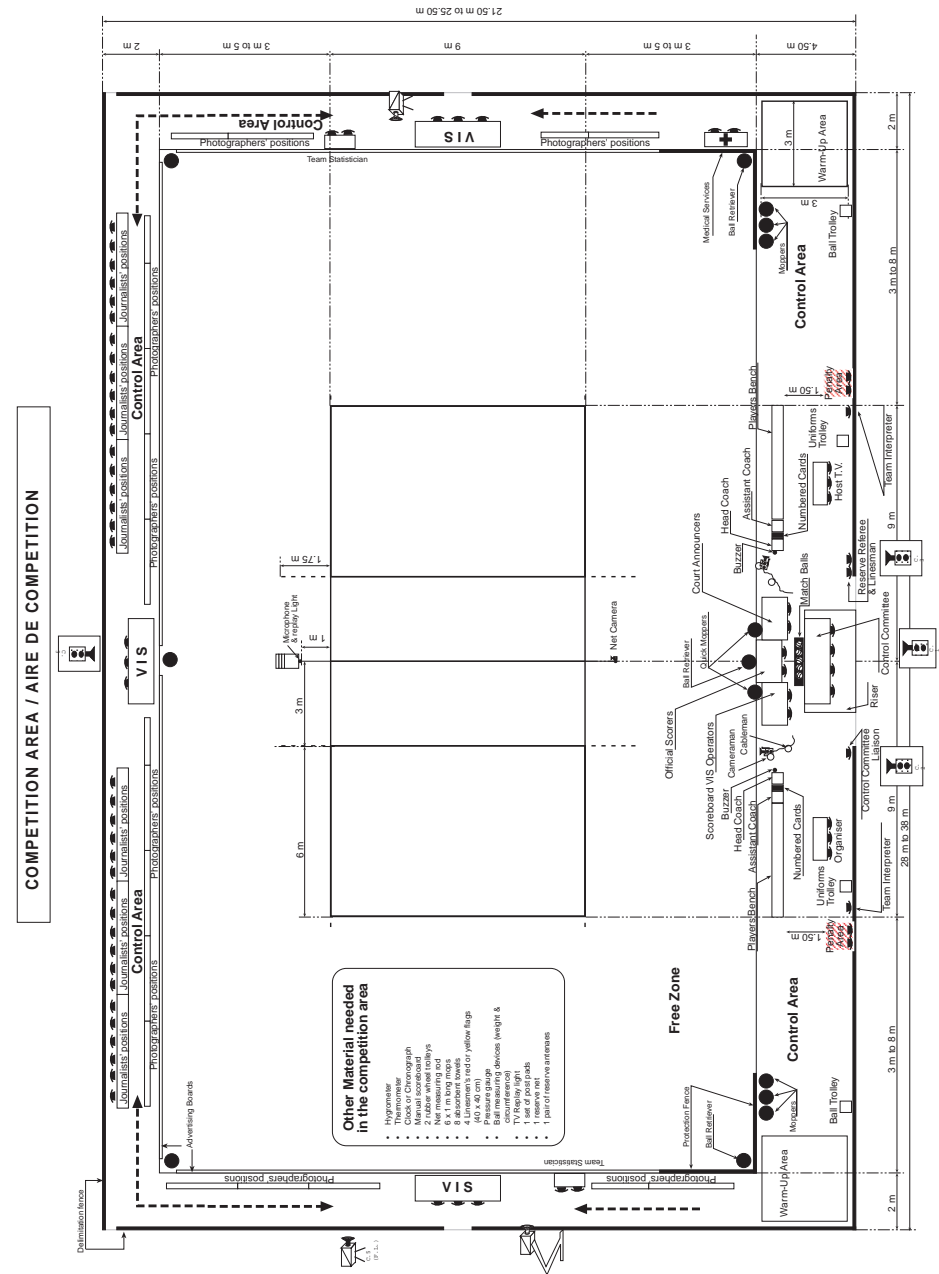

THE PLAYING AREA / L'AIRE DE JEU

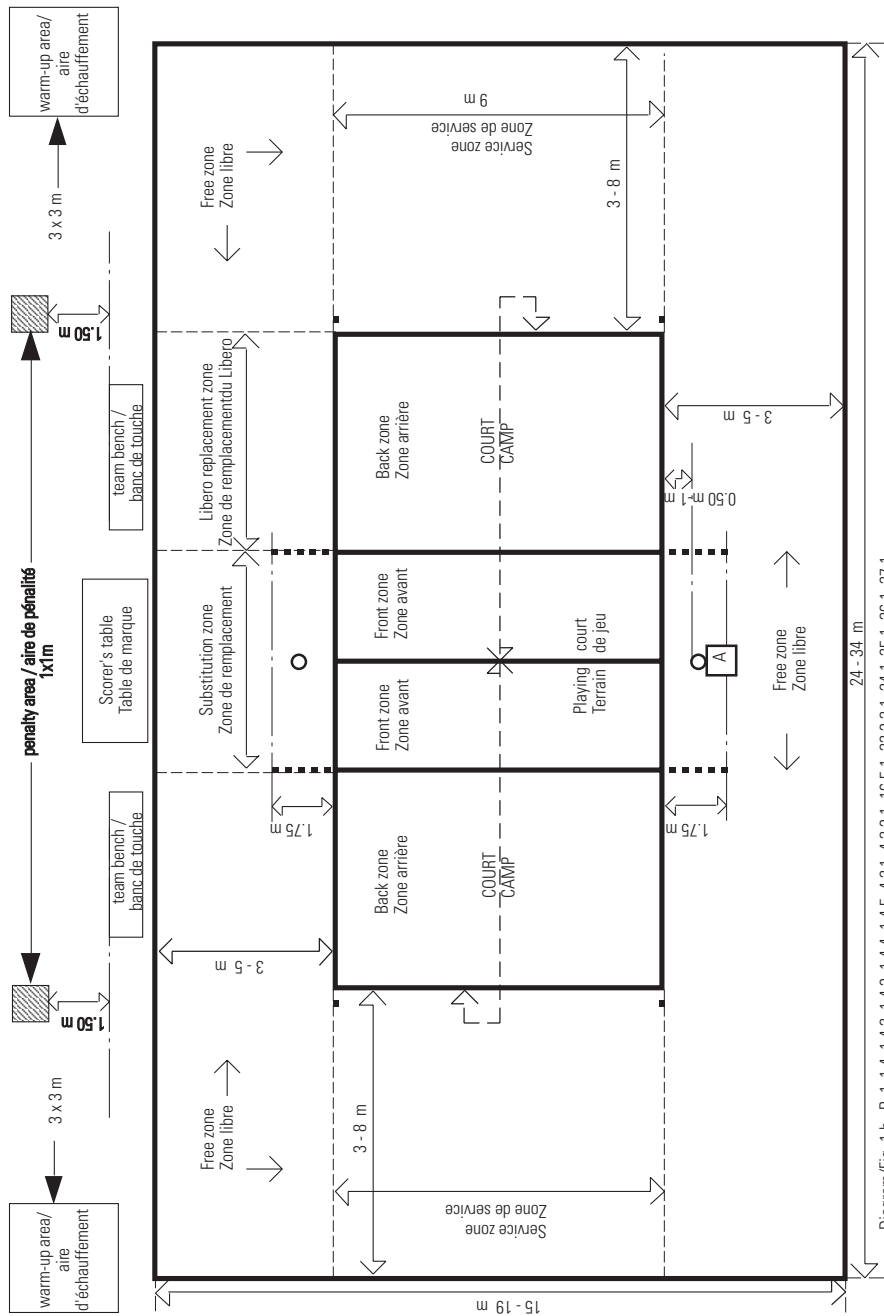

Diagram/Fig. 1.b R. 1.1.4, 1.4.2, 1.4.3, 1.4.4, 1.4.5, 4.2.1, 4.2.3.1, 16.5.1, 22.3.2.1, 24.1, 25.1, 26.1, 27.1



THE PLAYING COURT / LE TERRAIN DE JEU

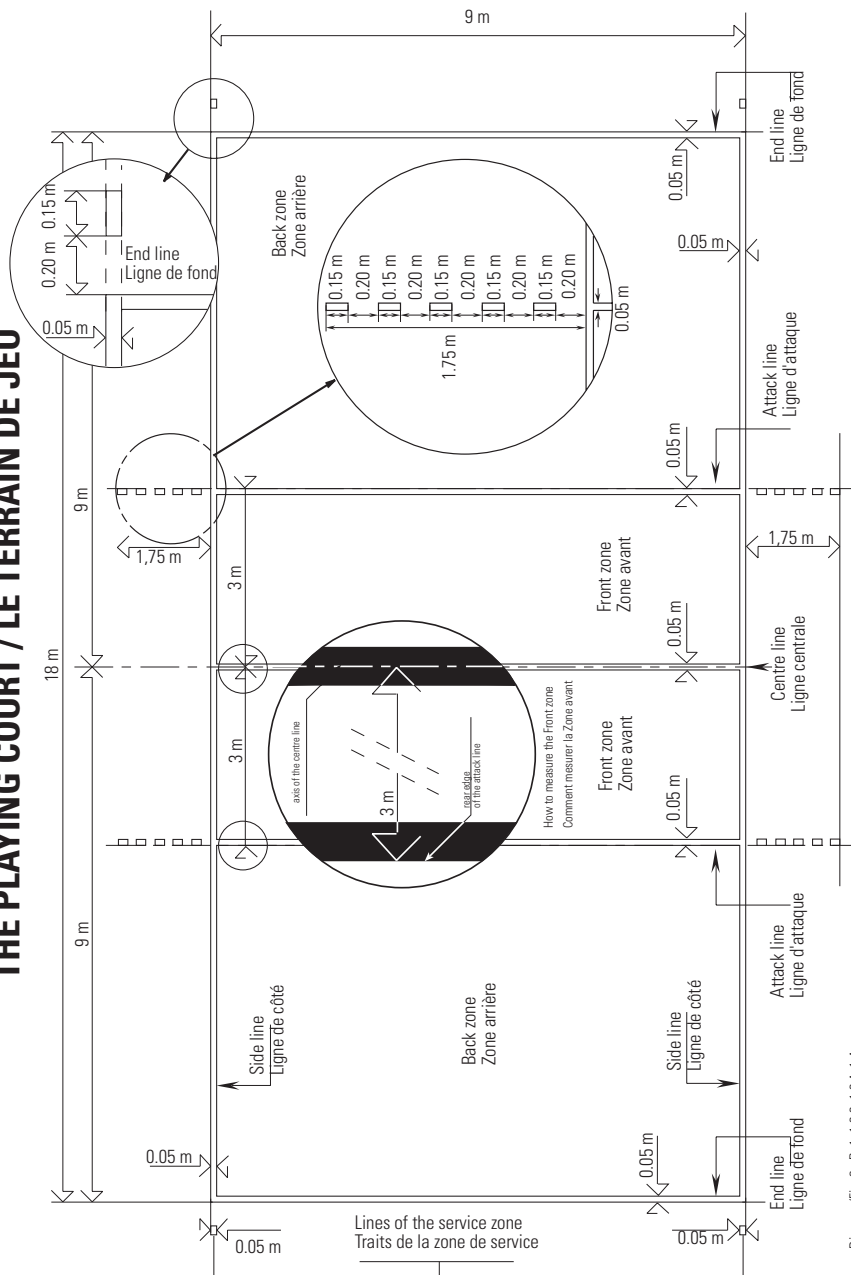

Diagram/Fig. 2 - R. 1.1.3.3, 1.3.4, 1.4



DESIGN OF THE NET / DESSIN DU FILET

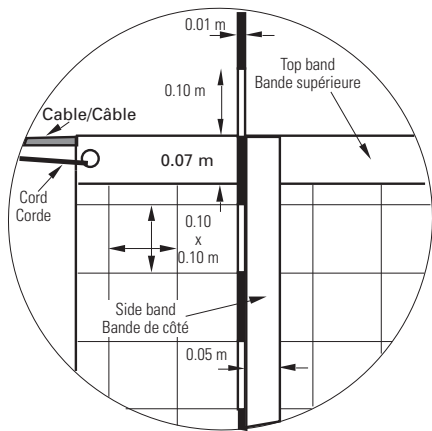
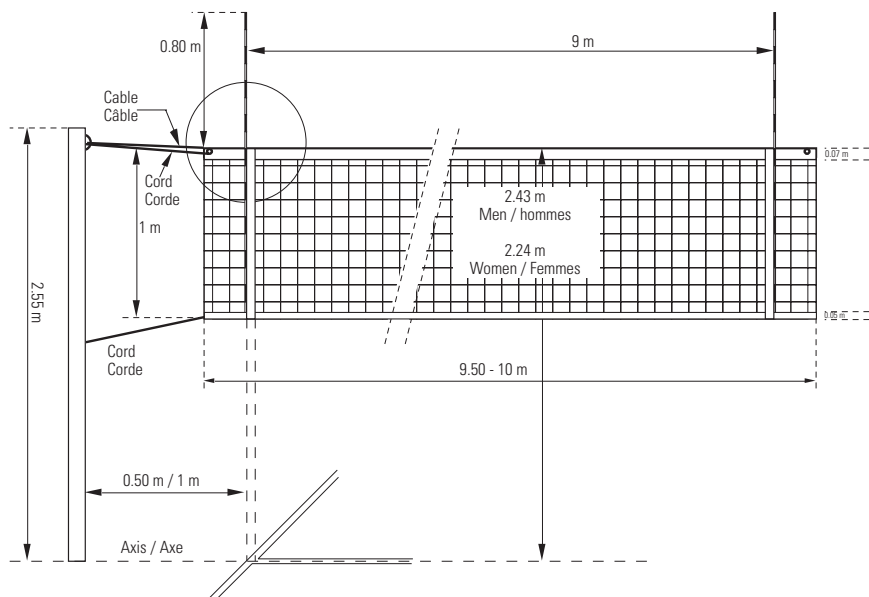

Diagram/Fig. 3 - R. 2, 2.2, 2.3, 2.4, 2.5.1

POSITION DES JOUEURS

POSITION OF PLAYERS

Exemple A : Détermination des positions entre un joueur avant et son arrière correspondant

Example A : Determination of the positions between a front-row player and the corresponding back-row player

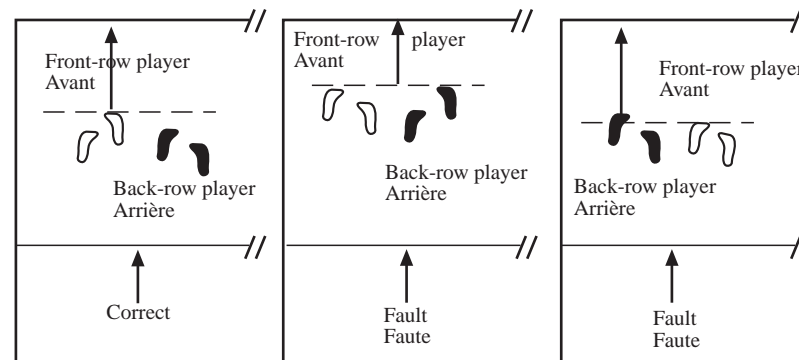

Exemple B : Détermination des positions entre les joueurs de la même ligne

Example B : Determination of the positions between players of the same row

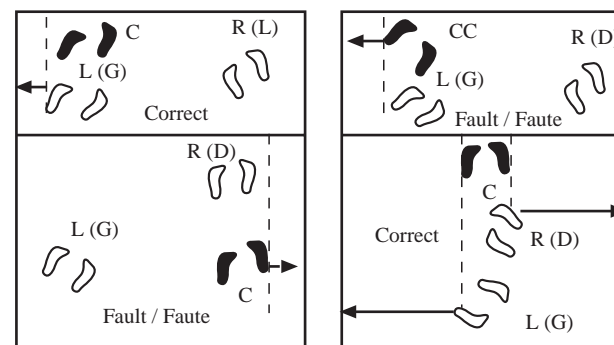

- C = Centre player / Joueur centre
- R(D) = Right player / Joueur droit
- L(G) = Left player / Joueur gauche

Diagram / Fig.4 - R. 7.4, 7.4.3, 7.5

**BALL CROSSING THE VERTICAL PLANE OF THE NET TO THE OPPONENT COURT
BALLON TRAVERSANT LE PLAN VERTICAL DU FILET EN DIRECTION DU CAMP ADVERSE**

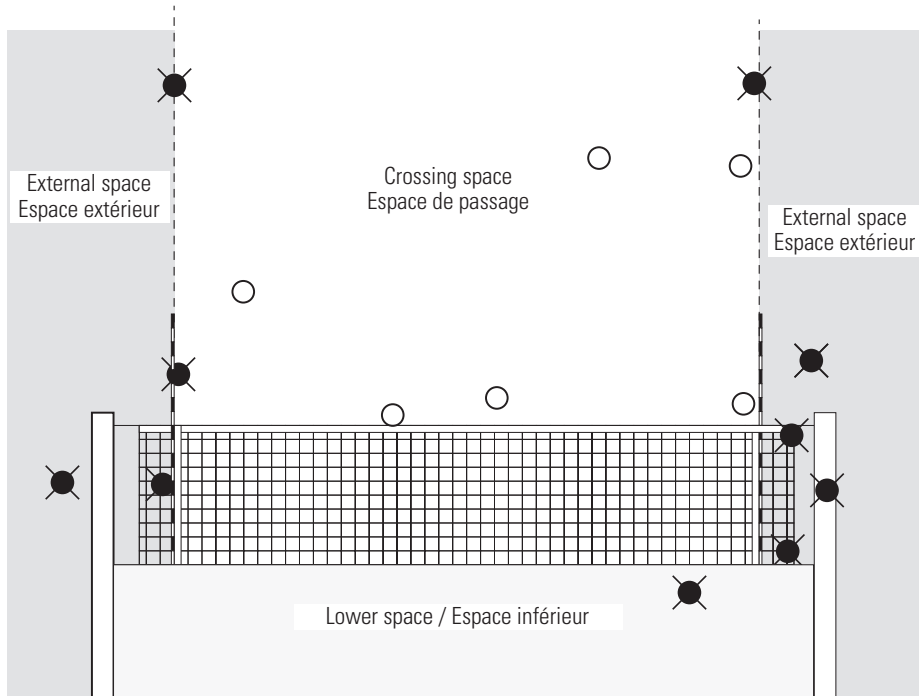

- ⊗ = Fault / Faute
- = Correct crossing / Passage correct

Diagram / Fig. 5 - R. 2.4, 9.4.3, 9.4.4, 9.4.5, 11.1.1

**COLLECTIVE SCREEN
ECRAN COLLECTIF**

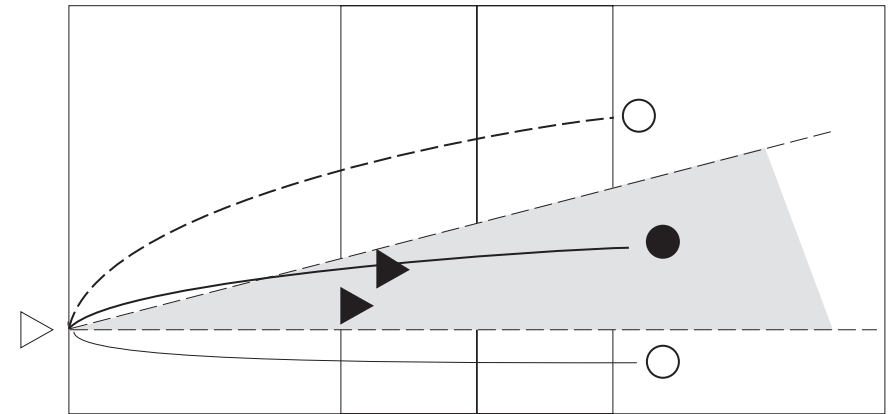

- = Correct
- = Fault / Faute

Diagram / Fig. 6 R. 13.5.2

**COMPLETED BLOCK
CONTRE EFFECTIF**

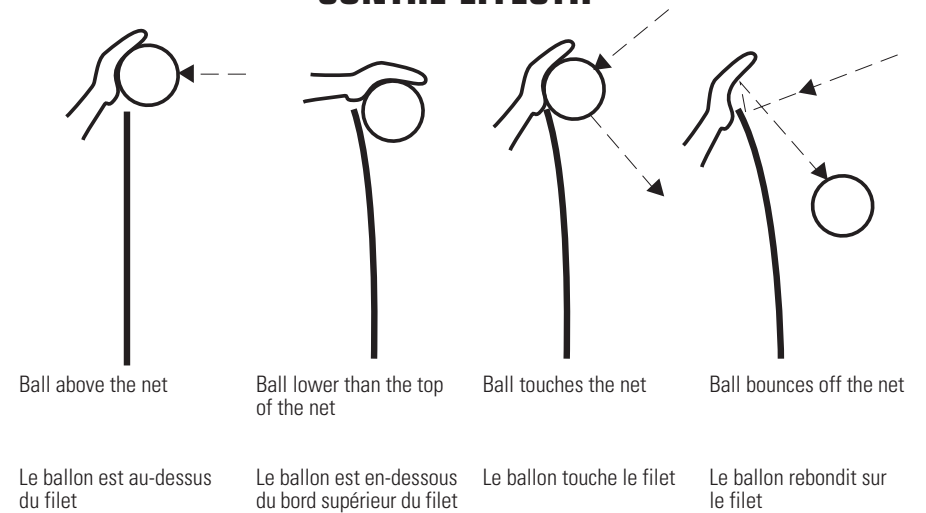

Diagram / Fig. 7 R. 15.1.3

BACK ROW PLAYER'S ATTACK ATTAQUE D'UN ARRIERE

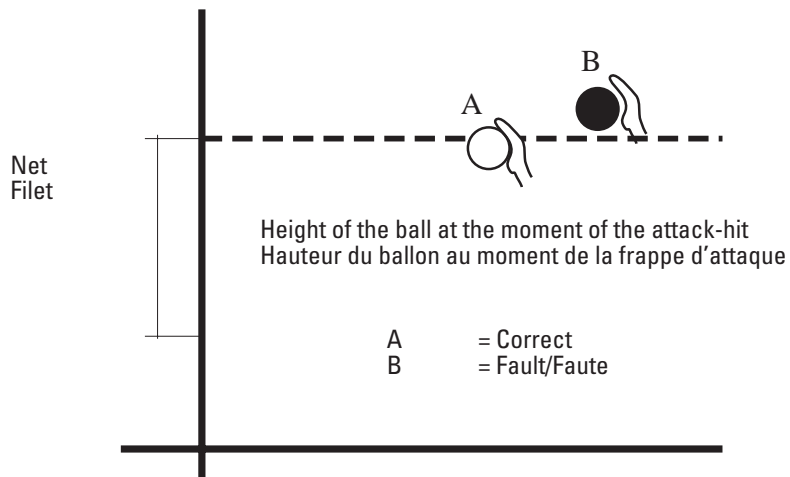
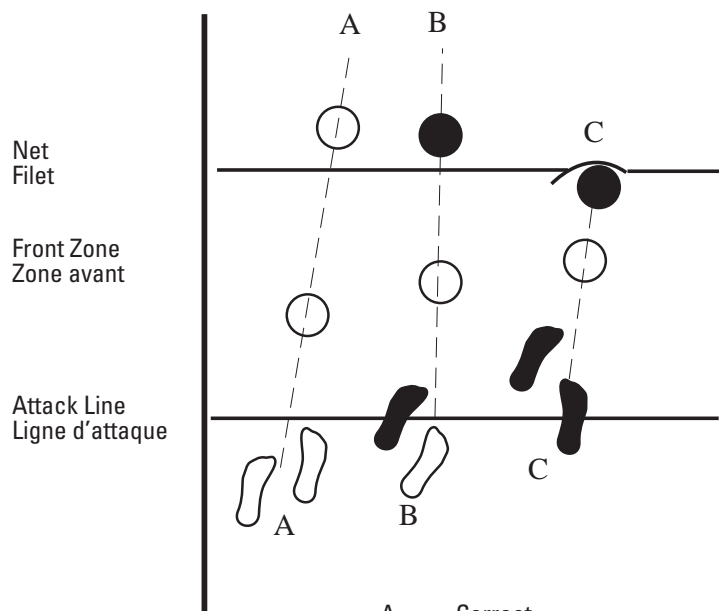

Diagram / Fig. 8 - R. 14.2.2, 14.2.3

MISCONDUCT SANCTION SCALE

CATEGORIES	OCCURRENCE (for a team)	OFFENDER	SANCTION	CARDS	CONSEQUENCE
RUDE CONDUCT	• First	Any member	Penalty	Yellow	Loss of Rally
	• Second	Same member	Expulsion	Red	Shall leave the playing area and stay in the Penalty Area for the remainder of the set
	• Third	Same member	Disqualification	Red + Yellow jointly	Shall leave the Competition Control Area for the rest of the match
OFFENSIVE CONDUCT	• First	Any member	Expulsion	Red	Shall leave the playing area and stay in the Penalty Area for the remainder of the set
	• Second	Same Member	Disqualification	Red + Yellow jointly	Shall leave the Competition Control Area for the rest of the match
AGGRESSION	• First	Any member	Disqualification	Red + Yellow jointly	Shall leave the Competition Control Area for the rest of the match
DELAY SANCTION SCALE					
DELAY	• First	Any member of the team	Delay Warning	Hand Signal N° 25 with no card	Prevention - No penalty
	• Second (and subsequents)	Any member of the team	Delay Penalty	Hand signal N° 25 with yellow card	Loss of rally

ECHELLE DES SANCTIONS POUR MECONDUITE

CATEGORIES	OCCURRENCE (dans une équipe)	AUTEUR	SANCTION	CARTONS	CONSEQUENCE
CONDUITE GROSSIERE	• Première	Un joueur quelconque	Pénalité	Jaune	Perte de l'échange de jeu
	• Seconde	Le même joueur	Expulsion	Rouge	Doit quitter l'aire de jeu et demeurer dans la zone de Pénalisation pour le reste du set
	• Troisième	Le même joueur	Disqualification	Rouge + Jaune ensemble	Doit quitter l'Aire de contrôle de la Compétition pour le reste du match
CONDUITE INJURIEUSE	• Première	Un joueur quelconque	Expulsion	Rouge	Doit quitter l'aire de jeu et demeurer dans la zone de Pénalisation pour le reste du set
	• Seconde	Le même joueur	Disqualification	Rouge + Jaune ensemble	Doit quitter l'Aire de contrôle de la Compétition pour le reste du match
AGRESSION	• Première	Un joueur quelconque	Disqualification	Rouge + Jaune ensemble	Doit quitter l'Aire de contrôle de la Compétition pour le reste du match
ECHELLE DES SANCTIONS POUR RETARD					
RETARD	• Première	Un joueur de l'équipe	Avertissement pour retard	Signal N° 25 sans carton	Prévention - Pas de pénalisation
	• Seconde (et suivantes)	Un joueur de l'équipe	Pénalité pour retard	Signal N° 25 avec carton jaune	Perte de l'échange de jeu

Diagram / Fig. 9 R. 22.3, 22.4.2

LOCATION OF THE REFEREEING CORPS AND THEIR ASSISTANTS EMPLACEMENT DU CORPS ARBITRAL ET DE LEURS ASSISTANTS

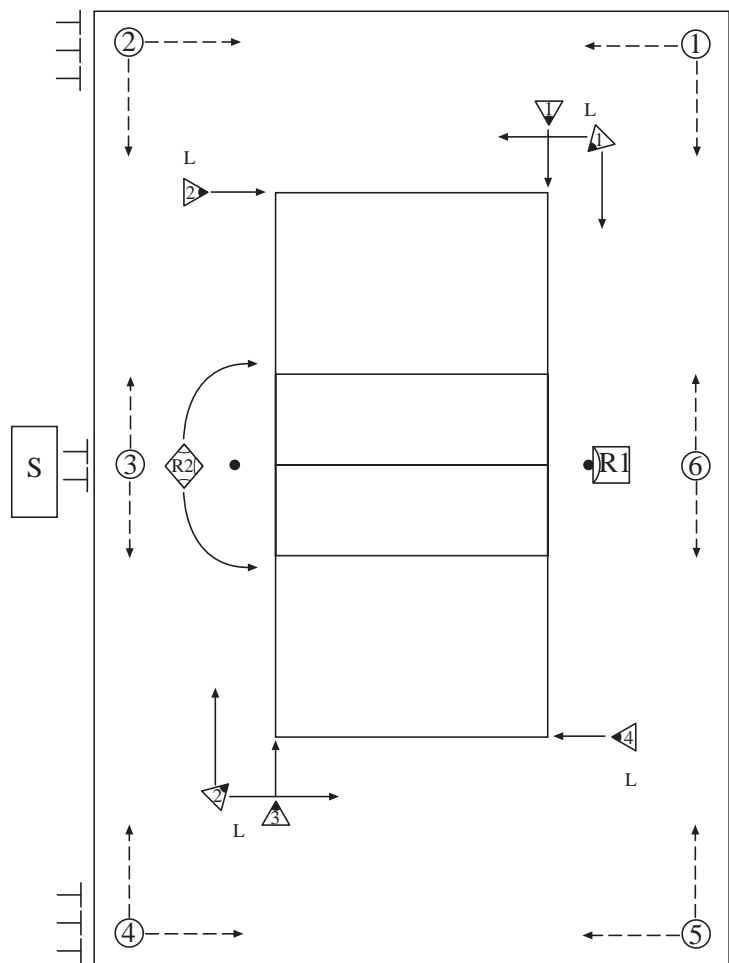



- R1 = First Referee / Premier arbitre
- ◆ R2 = Second Referee / Second arbitre
- S = Scorer / Marqueur
- ▶ L = Linesjudges / Juges de ligne (numbers 1-4 or 1-2 / numérotés 1-4 ou 1-2)
- ④ = Ball Retrievers / Ramasseurs de ballon (numbers 1-6 / numérotés 1-6)
- └ = Floor Moppers / Balayeurs et Essuyeurs

Diagram / Fig. 10 - R 3.3, 24.1, 25.1, 26.1, 27.1

REFEREES' OFFICIAL HAND SIGNALS Diagram 11, 1 to 5 R. 28.1

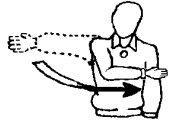
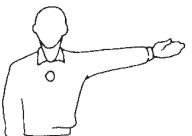
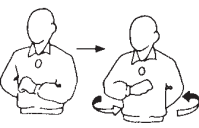
GESTES OFFICIELS DES ARBITRES R. 28.1 Fig. 11, 1 à 5





Situations to be indicated	Hand signals to be executed by First referee F Second referee S	Gestes à exécuter par le premier arbitre F le second arbitre S	Faits à signaler
Authorisation to serve R. 13.3	F	1 	Autorisation de servir R. 13.3
Team to serve R. 13.3 R. 23.2.3.1	F S	2 	Equipe au service R. 13.3 R. 23.2.3.1
Change of courts R. 19.2	F	3 	Changement de terrain R. 19.2
Time-out R. 16.2.1 R. 16.4	F S	4 	Temps-mort R. 16.2.1 R. 16.4
Substitution R. 16.2.1 R. 16.5	F S	5 	Remplacement R. 16.2.1 R. 16.5

REFEREES' OFFICIAL HAND SIGNALS

Diagram 11, 6 to 10 R. 28.1

GESTES OFFICIELS DES ARBITRES

R. 28.1 Fig. 11, 6 à 10





Situations to be indicated	Hand signals to be executed by		Gestes à exécuter par	Faits à signaler
	First referee	Second referee		
Misconduct penalty R. 22.3.1, R. 22.6	F	S	6 	Conduite incorrecte pénalisation R. 22.3.1, R. 22.6
Expulsion R. 22.3.2, R. 22.6	F	S	7 	Expulsion R. 22.3.2, R. 22.6
Disqualification R. 22.3.3, R. 22.6	F	S	8 	Disqualification R. 22.3.3, R. 22.6
End of set (or match) R. 6.2 R. 6.3	F	S	9 	Fin du set (ou match) R. 6.2 R. 6.3
Ball not tossed or released at the service hit. R. 13.4.1	F	S	10 	Ballon non lancé ou lâché pendant la frappe de service. R. 13.4.1

REFEREES' OFFICIAL HAND SIGNALS

Diagram 11, 11 to 15 R. 28.1

GESTES OFFICIELS DES ARBITRES

R. 28.1 Fig. 11, 11 à 15



Situations to be indicated	Hand signals to be executed by		Gestes à exécuter par	Faits à signaler
	First referee	Second referee		
Delay in service R. 13.4.4	F	S	11 	Retard dans le service. R. 13.4.4
Blocking fault R. 15.6 or screening R. 13.5	F	S	12 	Faute du bloc. R. 15.6 ou écran R. 13.5
Positional or rotation fault R. 7.5 or R. 7.7	F	S	13 	Faute de position ou de rotation. R. 7.5 ou R. 7.7
Ball "in" R. 9.3	F	S	14 	Ballon "dedans" (in) R. 9.3
Ball "out" R. 9.4	F	S	15 	Ballon "dehors" (out) R. 9.4

REFEREES' OFFICIAL HAND SIGNALS

Diagram 11, 16 to 20 R. 28.1

GESTES OFFICIELS DES ARBITRES

R. 28.1 Fig. 11, 16 à 20

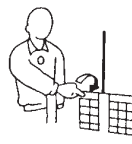
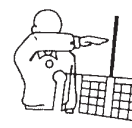





Situations to be indicated	Hand signals to be executed by		Gestes à exécuter par	Faits à signaler
	First referee	Second referee		
Catch R. 10.3.3	F	S	16  Lever lentement l'avant-bras, la paume de la main vers le haut.	Tenu R. 10.3.3
Double contact R. 10.3.4	F	S	17  Lever deux doigts écartés.	Double touche R. 10.3.4
Four hits R. 10.3.1	F	S	18  Lever quatre doigts écartés.	Quatre touches R. 10.3.1
Net touched by a player R. 12.4.4 Service hit touching the net and not staying in play R. 13.6.2.1	F	S	19  Montrer le côté correspondant du filet.	Filet touché par un joueur R. 12.4.4 Frappe de service touchant le filet et ne restant pas en jeu R. 13.6.2.1
Reaching beyond the net R. 12.4.1	F	S	20  Placer une main au dessus du filet, paume vers le bas.	Franchissement par dessus le filet R. 12.4.1

REFEREES' OFFICIAL HAND SIGNALS

Diagram 11, 21 to 25 R. 28.1

GESTES OFFICIELS DES ARBITRES

R. 28.1 Fig. 11, 21 à 25





Situations to be indicated	Hand signals to be executed by		Gestes à exécuter par	Faits à signaler
	First referee	Second referee		
Attack hit fault: by a back-row player, by a libero or on the opponent's service. R. 14.3.3, R. 14.3.4, R. 14.3.5 R. 14.3.6	F	S	21  Effectuer un mouvement de haut en bas avec l'avant-bras, la main ouverte.	Faute d'attaque de: un arrière, un libéro ou sur le service adverse R. 14.3.3, R. 14.3.4, R. 14.3.5 sur passe en touche haute avec les doigts par un libéro dans sa zone d'attaque R. 14.3.6
Penetration into the opponent's court or ball crossing the lower space. R. 12.2.2.2 R. 9.4.5	F	S	22  Montrer du doigt la ligne centrale	Pénétration dans le camp adverse ou ballon franchissant l'espace sous le filet. R. 12.2.2 R. 9.4.5
Double fault and replay R. 6.1.2.2 R. 10.1.2.3	F	S	23  Lever verticalement les deux pouces.	Double faute et échange à rejouer R. 6.1.2.2 R. 10.1.2.3
Ball touched R. 13.6.2.1	F	S	24  Frotter avec la paume d'une main les doigts de l'autre placée en position verticale	Ballon touché. R. 13.6.2.1
Delay warning R. 17.2.2	F	S	25  Warning	Avertissement pour retard de jeu R. 17.2.2
Delay penalty R. 17.2.3	F	S	25  Penalty	Pénalisation pour retard de jeu R. 17.2.3

LINEJUDGES' OFFICIAL FLAG SIGNALS

Diagram 12, 1 to 5 R. 28.2

GESTES OFFICIELS DES JUGES DE LIGNE

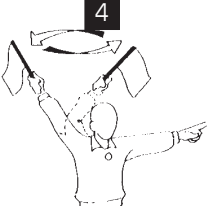
R. 28.2 Fig. 12, 1 à 5

Situations to be indicated	Flag signals to be executed by Signaux à exécuter par Linejudge L Juge de ligne		Faits à signaler
Ball "in" R. 9.3	L Point down with flag.	1  Abaisser le fanion.	Ballon "dedans" (in) R. 9.3
Ball "out" R. 9.4.1	L Raise flag vertically.	2  Lever le fanion.	Ballon "dehors" (out) R. 9.4.1
Ball touched R. 27.2.1.2	L Raise flag and touch the top with the palm of the free hand.	3  Lever le fanion et toucher le dessus avec la paume de la main libre.	Ballon touché R. 27.2.1.2
Ball out or foot fault by any player during service R. 9.4.2, 9.4.3, 9.4.4, R. 13.4.3, 27.2.1.4, R. 27.2.1.6	L Wave flag over the head and point to the antenna or the respective line	4  Agiter le fanion au-dessus de la tête et montrer du doigt l'antenne ou la ligne concernée.	Ballon hors jeu ou faute de pied d'un joueur au service. R. 9.4.2, 9.4.3, 9.4.4, R. 13.4.3, 27.2.1.4, R. 27.2.1.6
Judgement impossible	L Raise and cross both arms and hands in front of the chest.	5  Lever et croiser les deux avant-bras et mains devant la poitrine.	Judgement impossible